

## 200 Series Stepper motor powered pumps.

Specification Sheet 1 (last updated May 2013)

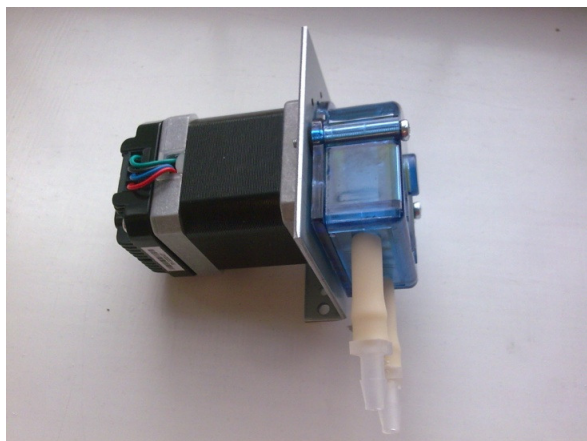

- Long life brushless motor.
- Quiet operation.
- Optional Built in driver & pulse generator (just connect supply) with speed control from 0.15 RPM up to 150 RPM via internal or external potentiometer or 0-5v.
- Optional DC socket & Plug top power supply complete with UK, EU & US AC connection heads.
- Various tube materials & sizes
- Ideal for R&D testing.
- OEM options for volume requirements
- Cased versions available

The 200 series, mini range of stepper motor driven peristaltic pumps offer a compact, accurate (#2) and reliable means of dosing a wide range of liquids. They are available in various configurations of tubing type/ID bore as detailed below. The easiest way to place an order or check prices is via our online shop at <http://www.williamson-shop.co.uk> but please contact us for any requirements not listed or to place an order over the phone.

### Selection Guide

Model Number	RPM	Tube type	Tube I.D	Approx. Flow range	Including Driver	External Speed control (not supplied)	Internal Speed control	Bracket mount speed control	DC SKT & AC #3 adapter
200.SM.016	see #1	Silicone	1.6mm	0.2 ml per revolution.	no	no	no	no	No
200.SMA.150.016	0.15-150	Silicone	1.6mm	0.05 to 30 ml/min	yes	no	yes	no	No
200.SMA.150.016PS	0.15-150	Silicone	1.6mm	0.05 to 30 ml/min	yes	no	yes	no	Yes
200.SMB.150.016	0.15-150	Silicone	1.6mm	0.05 to 30 ml/min	yes	yes	no	no	No
200.SMB.150.016S	0.15-150	Silicone	1.6mm	0.05 to 30 ml/min	yes	no	no	yes	No
200.SMB.150.016SC	0.15-150	Silicone	1.6mm	0.05 to 30 ml/min	yes	no	no	yes	Yes
200.SMB.150.016PS	0.15-150	Silicone	1.6mm	0.05 to 30 ml/min	yes	yes	no	no	Yes
200.SM.030	see #1	Silicone	3.0mm	0.58 ml/rev	no	no	no	no	No
200.SMA.150.030	0.15-150	Silicone	3.0mm	0.1 to 87 ml/min	yes	no	yes	no	No
200.SMA.150.030PS	0.15-150	Silicone	3.0mm	0.1 to 87 ml/min	yes	no	yes	no	Yes
200.SMB.150.030	0.15-150	Silicone	3.0mm	0.1 to 87 ml/min	yes	yes	no	no	No
200.SMB.150.030S	0.15-150	Silicone	3.0mm	0.1 to 87 ml/min	yes	no	no	yes	No
200.SMB.150.030SC	0.15-150	Silicone	3.0mm	0.1 to 87 ml/min	yes	no	no	yes	Yes
200.SMB.150.030PS	0.15-150	Silicone	3.0mm	0.1 to 87 ml/min	yes	yes	no	no	Yes
200.SM.050	see #1	Silicone	5.0mm	1.18 ml/rev	no	no	no	no	No
200.SMA.150.050	0.15-150	Silicone	5.0mm	0.2 to 177 ml/min	yes	no	yes	no	No
200.SMA.150.050PS	0.15-150	Silicone	5.0mm	0.2 to 177 ml/min	yes	no	yes	no	Yes
200.SMB.150.050	0.15-150	Silicone	5.0mm	0.2 to 177 ml/min	yes	yes	no	no	No
200.SMB.150.050S	0.15-150	Silicone	5.0mm	0.2 to 177 ml/min	yes	no	no	yes	No
200.SMB.150.050SC	0.15-150	Silicone	5.0mm	0.2 to 177 ml/min	yes	no	no	yes	Yes

## Williamson Manufacturing Company Ltd

The Street, Poynings, West Sussex, BN45 7AQ, United Kingdom.

Tel +44(0)1273 857752 Fax +44(0)1273 857511 Web [www.wmcpumps.com](http://www.wmcpumps.com)

200.SMB.150.050PS	0.15-150	Silicone	5.0mm	0.2 to 177 ml/min	yes	yes	no	no	Yes
-------------------	----------	----------	-------	-------------------	-----	-----	----	----	-----

### Selection Guide continued

Model Number	RPM	Tube type	Tube I.D	approx. Flow range	Including Driver	External Speed control (not supplied)	Internal Speed control	Bracket mount speed control	DC SKT & AC (#3) adapter
201.SM.016	see #1	Norprene®	1.6mm	0.19 ml per revolution.	no	no	no	no	no
201.SMA.150.016	0.15-150	Norprene®	1.6mm	0.05 to 29 ml/min	yes	no	yes	no	no
201.SMA.150.016PS	0.15-150	Norprene®	1.6mm	0.05 to 29 ml/min	yes	no	yes	no	yes
201.SMB.150.016	0.15-150	Norprene®	1.6mm	0.05 to 29 ml/min	yes	yes	no	no	no
201.SMB.150.016S	0.15-150	Norprene®	1.6mm	0.05 to 29 ml/min	yes	no	no	yes	no
201.SMB.150.016SC	0.15-150	Norprene®	1.6mm	0.05 to 29 ml/min	yes	no	no	yes	yes
201.SMB.150.016PS	0.15-150	Norprene®	1.6mm	0.05 to 29 ml/min	yes	yes	no	no	yes
201.SM.030	see #1	Norprene®	3.0mm	0.54 ml/rev	no	no	no	no	no
201.SMA.150.030	0.15-150	Norprene®	3.0mm	0.1 to 81 ml/min	yes	no	yes	no	no
201.SMA.150.030PS	0.15-150	Norprene®	3.0mm	0.1 to 81 ml/min	yes	no	yes	no	yes
201.SMB.150.030	0.15-150	Norprene®	3.0mm	0.1 to 81 ml/min	yes	yes	no	no	no
201.SMB.150.030S	0.15-150	Norprene®	3.0mm	0.1 to 81 ml/min	yes	no	no	yes	no
201.SMB.150.030SC	0.15-150	Norprene®	3.0mm	0.1 to 81 ml/min	yes	no	no	yes	yes
201.SMB.150.030PS	0.15-150	Norprene®	3.0mm	0.1 to 81 ml/min	yes	yes	no	no	yes
201.SM.050	see #1	Norprene®	5.0mm	1.08 ml/rev	no	no	no	no	no
201.SMA.150.050	0.15-150	Norprene®	5.0mm	0.2 to 162 ml/min	yes	no	yes	no	no
201.SMA.150.050PS	0.15-150	Norprene®	5.0mm	0.2 to 162 ml/min	yes	no	yes	no	yes
201.SMB.150.050	0.15-150	Norprene®	5.0mm	0.2 to 162 ml/min	yes	yes	no	no	no
201.SMB.150.050S	0.15-150	Norprene®	5.0mm	0.2 to 162 ml/min	yes	no	no	yes	no
201.SMB.150.050SC	0.15-150	Norprene®	5.0mm	0.2 to 162 ml/min	yes	no	no	yes	yes
201.SMB.150.050PS	0.15-150	Norprene®	5.0mm	0.2 to 162 ml/min	yes	yes	no	no	yes
202.SM.016	see #1	Viton®	1.6mm	0.13 ml/rev	no	no	no	no	no
202.SMA.150.016	0.15-150	Viton®	1.6mm	0.05 to 24 ml/min	yes	no	yes	no	no
202.SMA.150.016PS	0.15-150	Viton®	1.6mm	0.05 to 24 ml/min	yes	no	yes	no	yes
202.SMB.150.016	0.15-150	Viton®	1.6mm	0.05 to 24 ml/min	yes	yes	no	no	no
202.SMB.150.016S	0.15-150	Viton®	1.6mm	0.05 to 24 ml/min	yes	no	no	yes	no
202.SMB.150.016SC	0.15-150	Viton®	1.6mm	0.05 to 24 ml/min	yes	no	no	yes	yes
202.SMB.150.016PS	0.15-150	Viton®	1.6mm	0.05 to 24 ml/min	yes	yes	no	no	yes
202.SM.030	see #1	Viton®	3.0mm	0.45 ml/rev	no	no	no	no	no
202.SMA.150.030	0.15-150	Viton®	3.0mm	0.1 to 68 ml/min	yes	no	yes	no	no
202.SMA.150.030PS	0.15-150	Viton®	3.0mm	0.1 to 68 ml/min	yes	no	yes	no	yes
202.SMB.150.030	0.15-150	Viton®	3.0mm	0.1 to 68 ml/min	yes	yes	no	no	no
202.SMB.150.030S	0.15-150	Viton®	3.0mm	0.1 to 68 ml/min	yes	no	no	yes	no
202.SMB.150.030SC	0.15-150	Viton®	3.0mm	0.1 to 68 ml/min	yes	no	no	yes	yes
202.SMB.150.030PS	0.15-150	Viton®	3.0mm	0.1 to 68 ml/min	yes	yes	no	no	yes
202.SM.050	see #1	Viton®	5.0mm	0.9 ml/rev	no	no	no	no	no
202.SMA.150.050	0.15-150	Viton®	5.0mm	0.2 to 135 ml/min	yes	no	yes	no	no
202.SMA.150.050PS	0.15-150	Viton®	5.0mm	0.2 to 135 ml/min	yes	no	yes	no	yes

## Williamson Manufacturing Company Ltd

The Street, Poynings, West Sussex, BN45 7AQ, United Kingdom.

Tel +44(0)1273 857752 Fax +44(0)1273 857511 Web [www.wmcpumps.com](http://www.wmcpumps.com)

202.SMB.150.050	0.15-150	Viton®	5.0mm	0.2 to 135 ml/min	yes	yes	no	no	no
202.SMB.150.050S	0.15-150	Viton®	5.0mm	0.2 to 135 ml/min	yes	no	no	yes	no
202.SMB.150.050SC	0.15-150	Viton®	5.0mm	0.2 to 135 ml/min	yes	no	no	yes	yes
202.SMB.150.050PS	0.15-150	Viton®	5.0mm	0.2 to 135 ml/min	yes	yes	no	no	yes

Note #1 Customer driver defined speed, pump must not exceed 500 RPM.

Note #2 Expect some variation pump to pump due to manufacturing tolerances. We offer a calibration service, contact our office to discuss.

Note #3 D.C socket units are also supplied with D.C plug top power supply with UK, EU & USA - A.C connection heads.

### Stepper Motor.

Specification	
Step Angle	1.8 Degrees
Step Angle Accuracy.	5%
Phase Current	1.5 A
Phase resistance	2 ohms
Phase inductance	3.85 mH
Detent torque	2.4 Ncm
Rotor inertia	82 g/cm <sup>2</sup>
Insulation class	B
Number of leads	4

### Motor Driver Features:

10-30v DC input voltage (24-30v DC for Norprene or Viton tube), max 2A adjustable phase current.

16<sup>th</sup> Micro stepping.

Dual full H-Bridge with PWM constant current control.

### Control Features:

Embedded microcontroller.

Self pulse generation, automatic run on power up.

Speed control through 0-5v voltage input 0.15 – 150 RPM.

Optional external potentiometer speed control.

Optional internal potentiometer speed control.

## Williamson Manufacturing Company Ltd

The Street, Poynings, West Sussex, BN45 7AQ, United Kingdom.

Tel +44(0)1273 857752 Fax +44(0)1273 857511 Web [www.wmcpumps.com](http://www.wmcpumps.com)

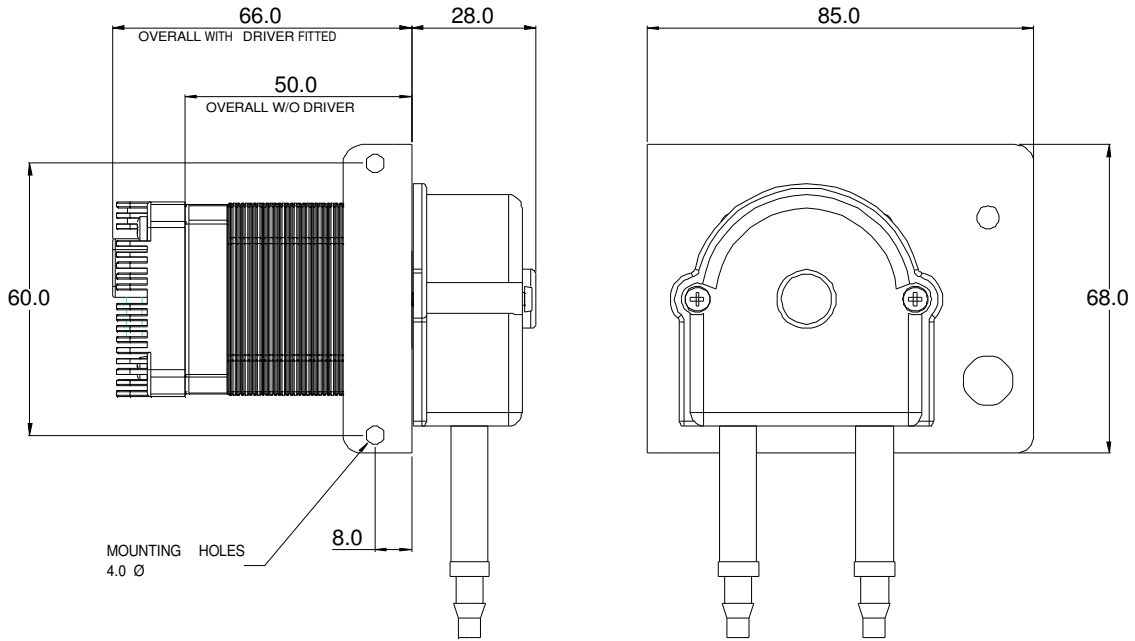

### Connection Details:

Note : 10-30v DC supply refers to pumps fitted with Silicone tube. Pumps fitted with Norprene or Viton require 24-30v DC.

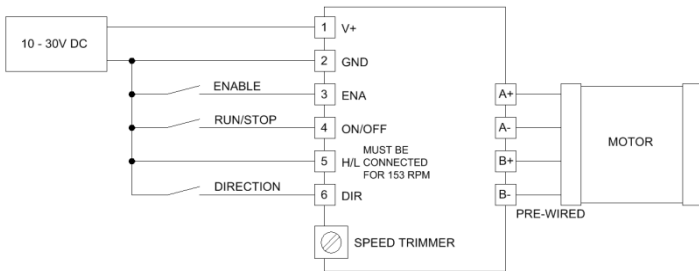

SMA TYPE DRIVER WITH DRIVER MOUNTED SPEED CONTROL.

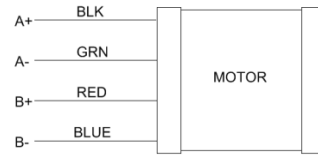

MOTOR ONLY

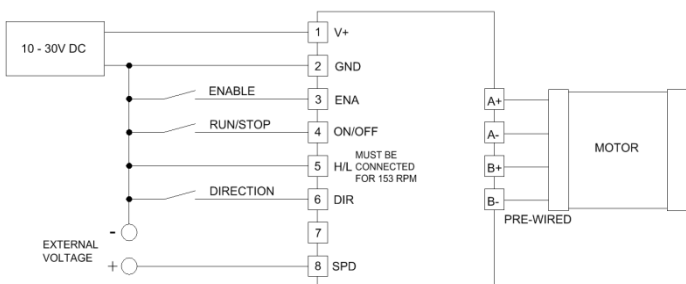

SMB DRIVER USING EXTERNAL 0-5V SPEED CONTROL.  
NOTE: 0V SUPPLY & 0V SPEED SIGNAL MUST BE COMMONED

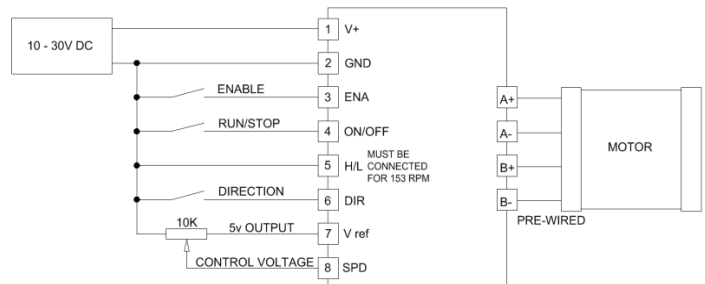

SMB DRIVER WITH EXTERNAL OR BRACKET MOUNT POTENTIOMETER SPEED CONTROL

H bridge enabled, rotate cw and run are default, connect to change.

**Williamson Manufacturing Company Ltd**  
 The Street, Poynings, West Sussex, BN45 7AQ, United Kingdom.  
 Tel +44(0)1273 857752 Fax +44(0)1273 857511 Web [www.wmcpumps.com](http://www.wmcpumps.com)

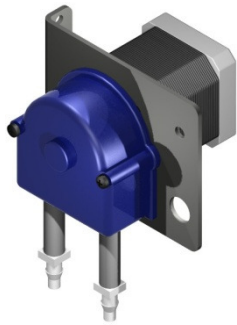

Stepper Motor only

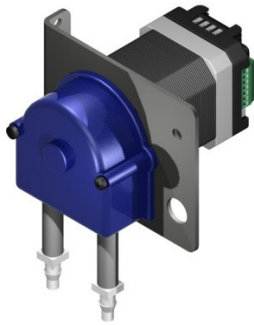

Stepper Motor & Driver (only)

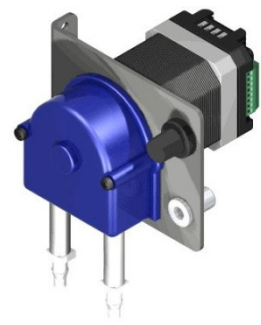

SMB with Bracket mount Speed control & D.C socket (Pre-wired)

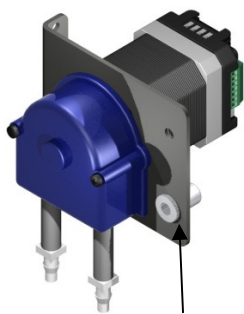

SMA type Driver & DC SKT (pre-wired)

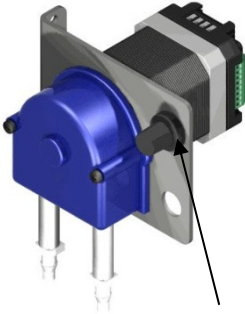

SMB type Driver with Bracket mount speed control (pre-wired)

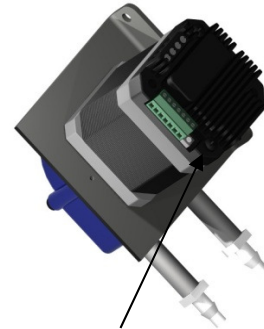

SMA type Driver mounted speed control

**Important:** The standard version of this pump is supplied sealed so the tube cannot be changed. The pump has been designed so that when the pump head has worn out it is changed as a whole. We are able to supply pumpheads unsealed for customers that wish to change the tubing periodically. Please contact our office for details.

## Williamson Manufacturing Company Ltd

The Street, Poynings, West Sussex, BN45 7AQ, United Kingdom.

Tel +44(0)1273 857752 Fax +44(0)1273 857511 Web [www.wmcpumps.com](http://www.wmcpumps.com)